



# PowerFlex 4 Adjustable Frequency AC Drive

FRN 4.xx

This Quick Start guide summarizes the basic steps needed to install, start-up and program the PowerFlex 4 Adjustable Frequency AC Drive. **The information provided Does Not replace the User Manual and is intended for qualified drive service personnel only.**

For detailed PowerFlex 4 information including EMC instructions, application considerations and related precautions refer to the PowerFlex 4 *User Manual*, Publication 22A-UM001... on the CD supplied with the drive or at [www.rockwellautomation.com/literature](http://www.rockwellautomation.com/literature).

## General Precautions

---



**ATTENTION:** The drive contains high voltage capacitors which take time to discharge after removal of mains supply. Before working on drive, ensure isolation of mains supply from line inputs [R, S, T (L1, L2, L3)]. Wait three minutes for capacitors to discharge to safe voltage levels. Failure to do so may result in personal injury or death.

Darkened display LEDs is not an indication that capacitors have discharged to safe voltage levels.



**ATTENTION:** Equipment damage and/or personal injury may result if parameter A092 [Auto Rstrt Tries] or A094 [Start At PowerUp] is used in an inappropriate application. Do not use this function without considering applicable local, national and international codes, standards, regulations or industry guidelines.



**ATTENTION:** Only qualified personnel familiar with adjustable frequency AC drives and associated machinery should plan or implement the installation, start-up and subsequent maintenance of the system. Failure to comply may result in personal injury and/or equipment damage.



**ATTENTION:** This drive contains ESD (Electrostatic Discharge) sensitive parts and assemblies. Static control precautions are required when installing, testing, servicing or repairing this assembly. Component damage may result if ESD control procedures are not followed. If you are not familiar with static control procedures, reference A-B publication 8000-4.5.2, "Guarding Against Electrostatic Damage" or any other applicable ESD protection handbook.



**ATTENTION:** An incorrectly applied or installed drive can result in component damage or a reduction in product life. Wiring or application errors, such as, undersizing the motor, incorrect or inadequate AC supply, or excessive ambient temperatures may result in malfunction of the system.

---

## Mounting Considerations

- Mount the drive upright on a flat, vertical and level surface.

Min. Panel Thickness	Screw Size	Screw Torque	DIN Rail
1.9 mm (0.0747 in.)	M4 (#8-32)	1.56-1.96 N-m (14-17 lb.-in.)	35 mm

- Protect the cooling fan by avoiding dust or metallic particles.
- Do not expose to a corrosive atmosphere.
- Protect from moisture and direct sunlight.

## Minimum Mounting Clearances

See page 12 for mounting dimensions.

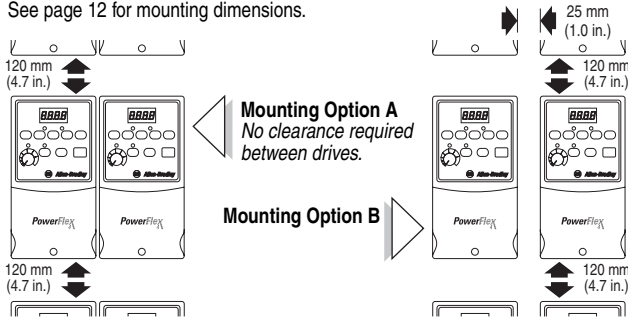

## Ambient Operating Temperatures

Ambient Temperature		Enclosure Rating	Minimum Mounting Clearances
Minimum	Maximum		
-10°C (14°F)	40°C (104°F)	IP 20/Open Type	Use Mounting Option A
		IP 30/NEMA 1/UL Type 1 <sup>(1)</sup>	Use Mounting Option B
	50°C (122°F)	IP 20/Open Type	Use Mounting Option B

<sup>(1)</sup> Rating requires installation of the PowerFlex 4 IP 30/NEMA 1/UL Type 1 option kit.

## General Grounding Requirements

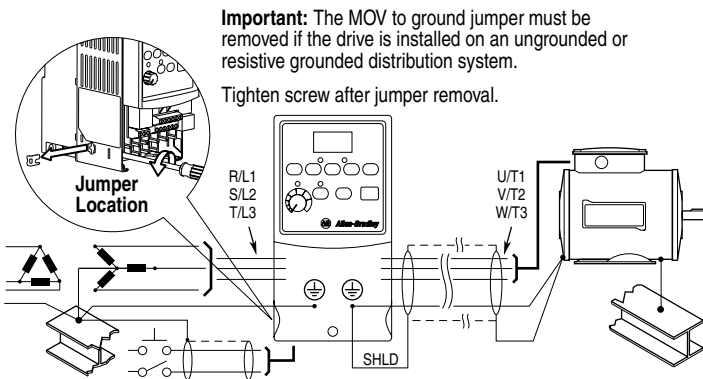

## CE Conformity

Refer to the PowerFlex 4 *User Manual* on the CD supplied with the drive for details on how to comply with the Low Voltage (LV) and Electromagnetic Compatibility (EMC) Directives.

# Specifications, Fuses and Circuit Breakers

## Drive Ratings

Catalog Number	Output Ratings		Input Ratings			Branch Circuit Protection			Power Dissipation
	kW (HP)	Amps	Voltage Range	kVA	Amps	Fuses	140M Motor Protectors <sup>(2)</sup>	Contactors	IP20 Open Watts
<b>100 - 120V AC (±10%) – 1-Phase Input, 0 - 230V 3-Phase Output</b>									
22A-V1P5N104	0.2 (0.25)	1.5	90-126	0.75	6.0	10	140M-C2E-C10	100-C09	32
22A-V2P3N104	0.4 (0.5)	2.3	90-126	1.15	9.0	15	140M-C2E-C16	100-C12	40
22A-V4P5N104	0.75 (1.0)	4.5	90-126	2.25	18.0	30	140M-D8E-C20	100-C23	55
22A-V6P0N104	1.1 (1.5)	6.0	90-126	3.0	24.0	40	140M-D8E-C25	100-C37	80
<b>200 - 240V AC (±10%) – 1-Phase<sup>(1)</sup> Input, 0 - 230V 3-Phase Output, NO BRAKE</b>									
22A-A1P4N103	0.2 (0.25)	1.4	180-265	0.7	3.2	6	140M-C2E-B40	100-C09	32
22A-A2P1N103	0.4 (0.5)	2.1	180-265	1.05	5.3	10	140M-C2E-B63	100-C09	40
22A-A3P6N103	0.75 (1.0)	3.6	180-265	1.8	9.2	15	140M-C2E-C16	100-C12	55
22A-A6P8N103	1.5 (2.0)	6.8	180-265	3.4	14.2	25	140M-C2E-C16	100-C16	85
22A-A9P6N103	2.2 (3.0)	9.6	180-265	4.8	19.6	30	140M-D8E-C25	100-C23	125
<b>200 - 240V AC (±10%) – 1-Phase<sup>(1)</sup> Input, 0 - 230V 3-Phase Output</b>									
22A-A1P5N104	0.2 (0.25)	1.5	180-265	0.75	5.0	10	140M-C2E-B63	100-C09	32
22A-A2P3N104	0.4 (0.5)	2.3	180-265	1.15	6.0	10	140M-C2E-B63	100-C09	40
22A-A4P5N104	0.75 (1.0)	4.5	180-265	2.25	10.0	15	140M-C2E-C16	100-C12	55
22A-A8P0N104	1.5 (2.0)	8.0	180-265	4.0	18.0	30	140M-D8E-C20	100-C23	85
<b>200 - 240V AC (±10%) – 3-Phase Input, 0 - 230V 3-Phase Output</b>									
22A-B1P5N104	0.2 (0.25)	1.5	180-265	0.75	1.8	3	140M-C2E-B25	100-C09	32
22A-B2P3N104	0.4 (0.5)	2.3	180-265	1.15	2.5	6	140M-C2E-B40	100-C09	40
22A-B4P5N104	0.75 (1.0)	4.5	180-265	2.25	5.2	10	140M-C2E-C10	100-C09	55
22A-B8P0N104	1.5 (2.0)	8.0	180-265	4.0	9.5	15	140M-C2E-C16	100-C12	85
22A-B012N104	2.2 (3.0)	12.0	180-265	5.5	15.5	25	140M-C2E-C16	100-C16	125
22A-B017N104	3.7 (5.0)	17.5	180-265	8.6	21.0	30	140M-F8E-C25	100-C23	180
<b>380 - 480V AC (±10%) – 3-Phase Input, 0 - 460V 3-Phase Output</b>									
22A-D1P4N104	0.4 (0.5)	1.4	340-528	1.4	1.8	3	140M-C2E-B25	100-C09	35
22A-D2P3N104	0.75 (1.0)	2.3	340-528	2.3	3.2	6	140M-C2E-B40	100-C09	50
22A-D4P0N104	1.5 (2.0)	4.0	340-528	4.0	5.7	10	140M-C2E-B63	100-C09	70
22A-D6P0N104	2.2 (3.0)	6.0	340-528	5.9	7.5	15	140M-C2E-C10	100-C09	100
22A-D8P7N104	3.7 (5.0)	8.7	340-528	8.6	9.0	15	140M-C2E-C16	100-C16	150

## Input/Output Ratings

Output Frequency: 0-240 Hz (Programmable)

Efficiency: 97.5% (Typical)

## Approvals



## Digital Control Inputs (Input Current = 6mA)

SRC (Source) Mode: 18-24V = ON  
0-6V = OFF

SNK (Sink) Mode: 0-6V = ON  
18-24V = OFF

## Analog Control Inputs

4-20mA Analog: 250 ohm input impedance  
0-10V DC Analog: 100k ohm input impedance  
External Pot: 1-10k ohms, 2 Watt minimum

## Control Output (Programmable Output, form C relay)

Resistive Rating: 3.0A at 30V DC, 125V AC and 240V AC Inductive Rating: 0.5A at 30V DC, 125V AC, and 240V AC

## Recommended Fuses and Circuit Breakers

Fuse: UL Class J, CC, T or Type BS88; 600V (550V) or equivalent. Circuit Breakers: HMCP or Bulletin 140U or equivalent.

## Protective Features

Motor Protection: I<sup>2</sup>t overload protection - 150% for 60 Secs, 200% for 3 Secs (Provides Class 10 protection)

Overcurrent: 200% hardware limit, 300% instantaneous fault

Over Voltage: 100-120V AC Input – Trip occurs at 405V DC bus voltage (equivalent to 150V AC incoming line)  
200-240V AC Input – Trip occurs at 405V DC bus voltage (equivalent to 290V AC incoming line)  
380-460V AC Input – Trip occurs at 810V DC bus voltage (equivalent to 575V AC incoming line)

Under Voltage: 100-120V AC Input – Trip occurs at 210V DC bus voltage (equivalent to 75V AC incoming line)  
200-240V AC Input – Trip occurs at 210V DC bus voltage (equivalent to 150V AC incoming line)  
380-480V AC Input – Trip occurs at 390V DC bus voltage (equivalent to 275V AC incoming line)

Control Ride Through: Minimum ride through is 0.5 Secs - typical value 2 Secs

Faultless Power Ride Through: 100 milliseconds

## Dynamic Braking

Internal brake IGBT included with all ratings except No Brake versions. Refer to Appendix B of the PowerFlex 4 User Manual on CD for ordering information.

(1) 200-240V AC - 1-Phase drives are also available with an integral EMC filter. Catalog suffix changes from N103 to N113 and N104 to N114.

(2) Refer to the Bulletin 140M Motor Protectors Selection Guide, publication 140M-SG001... to determine the frame and breaking capacity required for your application.

## Power Wiring

Power Wire Rating	Recommended Copper Wire
Unshielded 600V, 75°C (167°F) THHN/THWN	15 Mils insulated, dry location
Shielded 600V, 75°C or 90°C (167°F or 194°F) RHH/RHW-2	Belden 29501-29507 or equivalent
Shielded Tray rated 600V, 75°C or 90°C (167°F or 194°F) RHH/RHW-2	Shawflex 2ACD/3ACD or equivalent

### Power Terminal Block (A Frame Shown)

Terminal	Description
R/L1, S/L2	1-Phase Input
R/L1, S/L2, T/L3	3-Phase Input
U/T1	To Motor U/T1
V/T2	To Motor V/T2 =
W/T3	To Motor W/T3
BR+, BR-	Dynamic Brake Resistor Connection [0.75 kW (1 HP) ratings and higher]
⊕	Safety Ground - PE

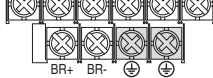

Switch any two motor leads to change forward direction.

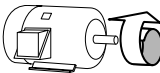

### Power Terminal Block Specifications

Frame	Maximum Wire Size <sup>(1)</sup>	Minimum Wire Size <sup>(1)</sup>	Torque
A	3.3 mm <sup>2</sup> (12 AWG)	0.8 mm <sup>2</sup> (18 AWG)	1.7-2.2 N-m (16-19 lb.-in.)
B	5.3 mm <sup>2</sup> (10 AWG)	1.3 mm <sup>2</sup> (16 AWG)	

<sup>(1)</sup> Maximum/minimum sizes that the terminal block will accept - these are not recommendations.

### Input Power Conditions

Input Power Condition	Corrective Action
Low Line Impedance (less than 1% line reactance)	<ul style="list-style-type: none"> <li>• Install Line Reactor<sup>(2)</sup></li> <li>• or Isolation Transformer</li> </ul>
Greater than 120 kVA supply transformer	
Line has power factor correction capacitors	
Line has frequent power interruptions	
Line has intermittent noise spikes in excess of 6000V (lightning)	
Phase to ground voltage exceeds 125% of normal line to line voltage	<ul style="list-style-type: none"> <li>• Remove MOV jumper to ground.</li> <li>• or Install Isolation Transformer with grounded secondary if necessary.</li> </ul>
Ungrounded Distribution System	

<sup>(2)</sup> Refer to Appendix B of the PowerFlex 4 *User Manual* on CD for accessory ordering information.

## I/O Wiring Recommendations<sup>(3)</sup>

Wire Type(s)	Description	Minimum Insulation Rating
Belden 8760/9460 (or equiv.)	0.8 mm <sup>2</sup> (18 AWG), twisted pair, 100% shield with drain.	300V 60 degrees C (140 degrees F)
Belden 8770 (or equiv.)	0.8 mm <sup>2</sup> (18 AWG), 3 conductor, shielded for remote pot only.	

<sup>(3)</sup> If the wires are short and contained within a cabinet which has no sensitive circuits, the use of shielded wire may not be necessary, but is always recommended.

### I/O Terminal Block Specifications

Maximum Wire Size <sup>(4)</sup>	Minimum Wire Size <sup>(4)</sup>	Torque
1.3 mm <sup>2</sup> (16 AWG)	0.13 mm <sup>2</sup> (26 AWG)	0.5-0.8 N-m (4.4-7 lb.-in.)

<sup>(4)</sup> Maximum / minimum that the terminal block will accept - these are not recommendations.

Refer to the PowerFlex 4 *User Manual* on CD for maximum power and control cable length recommendations

# Control Terminal Block

**(1) Important:** I/O Terminal 01 is always a coast to stop input except when P036 [Start Source] is set to “3-Wire” control. In three wire control, I/O Terminal 01 is controlled by P037 [Stop Mode]. All other stop sources are controlled by P037 [Stop Mode].

P036 [Start Source]	Stop	I/O Terminal 01 Stop
Keypad	Per P037	Coast
3-Wire	Per P037	Per P037
2-Wire	Per P037	Coast
RS485 Port	Per P037	Coast

Refer to the PowerFlex 4 User Manual on CD for detailed I/O wiring examples.

**Important:** The drive is shipped with a jumper installed between I/O Terminals 01 and 11. Remove this jumper when using I/O Terminal 01 as a stop or enable input.

**(2)** Two wire control shown. For three wire control use a momentary input on I/O Terminal 02 to command a start. Use a maintained input for I/O Terminal 03 to change direction.

Relay N.O.  
Relay Common  
Relay N.C.

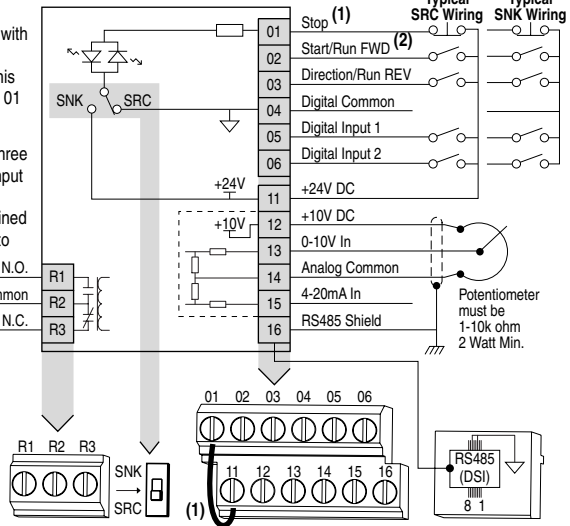

	30V DC	125V AC	240V AC
Resistive	3.0A	3.0A	3.0A
Inductive	0.5A	0.5A	0.5A

No.	Signal	Default	Description	Param.
R1	Relay N.O.	Fault	Normally open contact for output relay.	A055
R2	Relay Common	-	Common for output relay.	
R3	Relay N.C.	Fault	Normally closed contact for output relay.	A055
Sink/Source DIP Switch		Source (SRC)	Inputs can be wired as Sink (SNK) or Source (SRC) via DIP Switch setting.	
01	Stop <sup>(1)</sup>	Coast	The factory installed jumper or a normally closed input must be present for the drive to start.	P036 <sup>(1)</sup>
02	Start/Run FWD	Not Active	Command comes from the integral keypad by default. To disable reverse operation, see A095 [Reverse Disable].	P036, P037
03	Direction/Run REV	Not Active	To disable reverse operation, see A095 [Reverse Disable].	P036, P037, A095
04	Digital Common	-	For digital inputs. Electronically isolated with digital inputs from analog I/O.	
05	Digital Input 1	Preset Freq	Program with A051 [Digital In1 Sel].	A051
06	Digital Input 2	Preset Freq	Program with A052 [Digital In2 Sel].	A052
11	+24V DC	-	Drive supplied power for digital inputs. Maximum output current is 100mA.	
12	+10V DC	-	Drive supplied power for 0-10V external potentiometer. Maximum output current is 15mA.	P038
13	0-10V In <sup>(3)</sup>	Not Active	For external 0-10V input supply (input impedance = 100k ohm) or potentiometer wiper.	P038
14	Analog Common	-	For 0-10V In or 4-20mA In. Electronically isolated with analog inputs from digital I/O.	
15	4-20mA In <sup>(3)</sup>	Not Active	For external 4-20mA input supply (input impedance = 250 ohm).	P038
16	RS485 (DSI) Shield	-	Terminal should be connected to safety ground - PE when using the RS485 (DSI) communications port.	

<sup>(3)</sup> Only one analog frequency source may be connected at a time. If more than one reference is connected at the same time, an undetermined frequency reference will result.

---

## Prepare For Drive Start-Up

---



**ATTENTION:** Power must be applied to the drive to perform the following start-up procedures. Some of the voltages present are at incoming line potential. To avoid electric shock hazard or damage to equipment, only qualified service personnel should perform the following procedure. Thoroughly read and understand the procedure before beginning. If an event does not occur while performing this procedure, **Do Not Proceed. Remove All Power** including user supplied control voltages. User supplied voltages may exist even when main AC power is not applied to the drive. Correct the malfunction before continuing.

---

### Before Applying Power to the Drive

- 1. Confirm that all inputs are connected to the correct terminals and are secure.
- 2. Verify that AC line power at the disconnect device is within the rated value of the drive.
- 3. Verify that any digital control power is 24 volts.
- 4. Verify that the Sink (SNK)/Source (SRC) Setup DIP Switch is set to match your control wiring scheme. See page 5 for location.

**Important:** The default control scheme is Source (SRC). The Stop terminal is jumpered (I/O Terminals 01 and 11) to allow starting from the keypad. If the control scheme is changed to Sink (SNK), the jumper must be removed from I/O Terminals 01 and 11 and installed between I/O Terminals 01 and 04.

- 5. Verify that the Stop input is present or the drive will not start.

**Important:** If I/O Terminal 01 is used as a stop input, the jumper between I/O Terminals 01 and 11 must be removed.

### Applying Power to the Drive

- 6. Apply AC power and control voltages to the drive.
- 7. Familiarize yourself with the integral keypad features (see next page) before setting any Program Group parameters.

### Start, Stop, Direction and Speed Control

Factory default parameter values allow the drive to be controlled from the integral keypad. No programming is required to start, stop, change direction and control speed directly from the integral keypad.

**Important:** To disable reverse operation, see A095 [Reverse Disable].

If a fault appears on power up, refer to page 11 for an explanation of the fault code. For complete troubleshooting information, refer to the PowerFlex 4 *User Manual* on the CD supplied with the drive.

## Integral Keypad

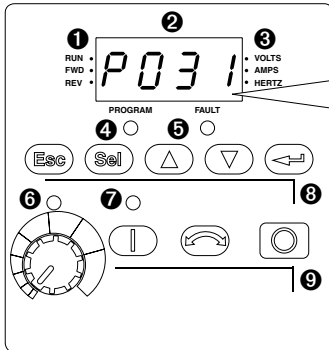

Menu	Description
<i>d</i>	<b>Display Group (View Only)</b> Consists of commonly viewed drive operating conditions.
<i>P</i>	<b>Basic Program Group</b> Consists of most commonly used programmable functions.
<i>A</i>	<b>Advanced Program Group</b> Consists of remaining programmable functions.
<i>F</i>	<b>Fault Designator</b> Consists of list of codes for specific fault conditions. Displayed only when fault is present.









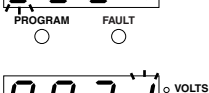

No.	LED	LED State	Description
1	Run/Direction Status	Steady Red	Indicates drive is running and commanded motor direction.
		Flashing Red	Drive has been commanded to change direction. Indicates actual motor direction while decelerating to zero.
2	Alphanumeric Display	Steady Red	Indicates parameter number, parameter value, or fault code.
		Flashing Red	Single digit flashing indicates that digit can be edited. All digits flashing indicates a fault condition.
3	Displayed Units	Steady Red	Indicates the units of the parameter value being displayed.
4	Program Status	Steady Red	Indicates parameter value can be changed.
5	Fault Status	Flashing Red	Indicates drive is faulted.
6	Pot Status	Steady Green	Indicates potentiometer on Integral Keypad is active.
7	Start Key Status	Steady Green	Indicates Start key on Integral Keypad is active. The Reverse key is also active unless disabled by A095 [Reverse Disable].

No.	Key	Name	Description
8		Escape	Back one step in programming menu. Cancel a change to a parameter value and exit Program Mode.
		Select	Advance one step in programming menu. Select a digit when viewing parameter value.
		Up Arrow Down Arrow	Scroll through groups and parameters. Increase/decrease the value of a flashing digit.
		Enter	Advance one step in programming menu. Save a change to a parameter value.
9		Potentiometer	Used to control speed of drive. Default is active. Controlled by parameter P038.
		Start	Used to start the drive. Default is active. Controlled by parameter P036.
		Reverse	Used to reverse direction of the drive. Default is active. Controlled by parameters P036 and A095.
		Stop	Used to stop the drive or clear a fault. This key is always active. Controlled by parameter P037.

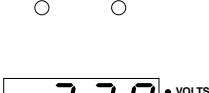
## Viewing and Editing Parameters

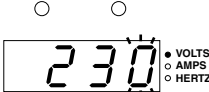
The last user-selected Display Group parameter is saved when power is removed and is displayed by default when power is reapplied.

The following is an example of basic integral keypad and display functions. This example provides basic navigation instructions and illustrates how to program the first Program Group parameter.

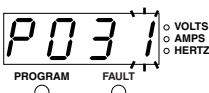
Step	Key(s)	Example Displays
1. When power is applied, the last user-selected Display Group parameter number is briefly displayed with flashing characters. The display then defaults to that parameter's current value. (Example shows the value of d001 [Output Freq] with the drive stopped.)		
2. Press Esc once to display the Display Group parameter number shown on power-up. The parameter number will flash.	Esc	
3. Press Esc again to enter the group menu. The group menu letter will flash.	Esc	
4. Press the Up Arrow or Down Arrow to scroll through the group menu (d, P and A).	△ or ▽	
5. Press Enter or Sel to enter a group. The right digit of the last viewed parameter in that group will flash.	← or Sel	
6. Press the Up Arrow or Down Arrow to scroll through the parameters that are in the group.	△ or ▽	
7. Press Enter or Sel to view the value of a parameter. If you do not want to edit the value, press Esc to return to the parameter number.	← or Sel	
8. Press Enter or Sel to enter program mode to edit the parameter value. The right digit will flash and the Program LED will illuminate if the parameter can be edited.	← or Sel	
9. Press the Up Arrow or Down Arrow to change the parameter value. If desired, press Sel to move from digit to digit or bit to bit. The digit or bit that you can change will flash.	△ or ▽	
10. Press Esc to cancel a change. The digit will stop flashing, the previous value is restored and the Program LED will turn off. Or	Esc	
Press Enter to save a change. The digit will stop flashing and the Program LED will turn off.	←	
11. Press Esc to return to the parameter list. Continue to press Esc to back out of the programming menu. If pressing Esc does not change the display, then d001 [Output Frequency] is displayed. Press Enter or Sel to enter the group menu.	Esc	



## Display Group Parameters

No.	Parameter	Min/Max	Display/Options
d001	[Output Freq]	0.0/[Maximum Freq]	0.1 Hz
d002	[Commanded Freq]	0.0/[Maximum Freq]	0.1 Hz
d003	[Output Current]	0.00/(Drive Amps × 2)	0.01 Amps
d004	[Output Voltage]	0/Drive Rated Volts	1 VAC
d005	[DC Bus Voltage]	Based on Drive Rating	1 VDC
d006	[Drive Status]	0/1 (1 = Condition True)	Bit 3 Decelerating      Bit 2 Accelerating      Bit 1 Forward              Bit 0 Running
d007- d009	[Fault x Code]	F2/F122	F1
d010	[Process Display]	0.00/9999	0.01 – 1
d012	[Control Source]	0/9	Digit 1 = Speed Command (See P038; 9 = "Jog Freq")      Digit 0 = Start Command (See P036; 9 = "Jog")
d013	[Contrl In Status]	0/1 (1 = Input Present)	Bit 3 Reserved              Bit 2 Stop Input              Bit 1 Dir/Run REV              Bit 0 Start/Run FWD
d014	[Dig In Status]	0/1 (1 = Input Present)	Bit 3 Reserved              Bit 2 Reserved              Bit 1 Digital In2 Sel              Bit 0 Digital In1 Sel
d015	[Comm Status]	0/1 (1 = Condition True)	Bit 3 Fault Occurred              Bit 2 RS485 Option              Bit 1 Transmitting              Bit 0 Receiving
d016	[Control SW Ver]	1.00/99.99	0.01
d017	[Drive Type]	1001/9999	1
d018	[Elapsed Run Time]	0/9999 Hrs	1 = 10 Hrs
d019	[Testpoint Data]	0/FFFF	1 Hex
d020	[Analog In 0-10V]	0.0/100.0%	0.1%
d021	[Analog In 4-20mA]	0.0/100.0%	0.1%
d024	[Drive Temp]	0/120 degC	1 degC

## Smart Start-Up with Basic Program Group Parameters

= Stop drive before changing this parameter.

No.	Parameter	Min/Max	Display/Options	Default
P031	[Motor NP Volts]	20/Drive Rated Volts	1 VAC	Based on Drive Rating
<input type="radio"/>	Set to the motor nameplate rated volts.			
P032	[Motor NP Hertz]	10/240 Hz	1 Hz	60 Hz
<input type="radio"/>	Set to the motor nameplate rated frequency.			
P033	[Motor OL Current]	0.0/(Drive Rated Amps×2)	0.1 Amps	Based on Drive Rating
	Set to the maximum allowable motor current.			
P034	[Minimum Freq]	0.0/240.0 Hz	0.1 Hz	0.0 Hz
	Sets the lowest frequency the drive will output continuously.			
P035	[Maximum Freq]	0/240 Hz	1 Hz	60 Hz
<input type="radio"/>	Sets the highest frequency the drive will output.			
P036	[Start Source]	0/5	0 = "Keypad" <sup>(1)</sup> 3 = "2-W Lvl Sens" 1 = "3-Wire"      4 = "2-W Hi Speed" 2 = "2-Wire"      5 = "Comm Port"	0
<input type="radio"/>	Sets the control scheme used to start the drive.			
	<sup>(1)</sup> When active, the Reverse key is also active unless disabled by A095 [Reverse Disable].			
P037	[Stop Mode]	0/7	0 = "Ramp, CF" <sup>(1)</sup> 4 = "Ramp" 1 = "Coast, CF" <sup>(1)</sup> 5 = "Coast" 2 = "DC Brake, CF" <sup>(1)</sup> 6 = "DC Brake" 3 = "DCBrkAuto,CF" <sup>(1)</sup> 7 = "DC BrakeAuto"	0
	Active stop mode for all stop sources [e.g. keypad, run forward (I/O Terminal 02), run reverse (I/O Terminal 03), RS485 port] except as noted below.			
	<b>Important:</b> I/O Terminal 01 is always a coast to stop input except when P036 [Start Source] is set for "3-Wire" control. When in three wire control, I/O Terminal 01 is controlled by P037 [Stop Mode].			
	<sup>(1)</sup> Stop input also clears active fault.			
P038	[Speed Reference]	0/5	0 = "Drive Pot"      3 = "4-20mA Input" 1 = "InternalFreq"      4 = "Preset Freq" 2 = "0-10V Input"      5 = "Comm Port"	0
	Sets the source of the speed reference to the drive.			
	<b>Important:</b> When A051 or A052 [Digital Inx Sel] is set to option 2, 4, 5, 6, 13 or 14, and the digital input is active, A051 or A052 will override the speed reference commanded by this parameter. Refer to Chapter 1 of the PowerFlex 4 User Manual on CD for details.			
P039	[Accel Time 1]	0.0/600.0 Secs	0.1 Secs	10.0 Secs
	Sets the rate of accel for all speed increases.			
P040	[Decel Time 1]	0.1/600.0 Secs	0.1 Secs	10.0 Secs
	Sets the rate of decel for all speed decreases.			
P041	[Reset To Defaults]	0/1	0 = "Idle State" 1 = "Reset Defaults"	0
<input type="radio"/>	Resets all parameter values to factory defaults.			
P043	[Motor OL Ret]	0/1	0 = "Disabled"      1 = "Enabled"	0
	Enables/disables the Motor Overload Retention function.			

## Advanced Group Parameters

No.	Parameter	Min/Max	Display/Options	Default																				
A051	[Digital In1 Sel] /O Terminal 05	0/26	0 = "Not Used" 1 = "Acc 2 & Dec 2"	4																				
A052	[Digital In2 Sel] /O Terminal 06		2 = "Jog" 3 = "Aux Fault" 4 = "Preset Freq" 5 = "Local" 6 = "Comm Port" 7 = "Clear Fault"	8 = "RampStop,CF" 9 = "CoastStop,CF" 10 = "DCInjStop,CF" 11 = "Jog Forward" 12 = "Jog Reverse" 13 = "10V In Ctrl" 14 = "20mA In Ctrl" 26 = "Anlg Invert"																				
A055	[Relay Out Sel]	0/21	0 = "Ready/Fault" 1 = "At Frequency" 2 = "MotorRunning" 3 = "Reverse" 4 = "Motor Overld" 5 = "Ramp Reg"	6 = "Above Freq" 7 = "Above Cur" 8 = "Above DCVolt" 9 = "Retries Exst" 10 = "Above Anlg V" 20 = "ParamControl" 21 = "NonRec Fault"																				
A056	[Relay Out Level]	0.0/9999	0.1	0.0																				
A067	[Accel Time 2]	0.0/600.0 Secs	0.1 Secs	20.0 Secs																				
A068	[Decel Time 2]	0.1/600.0 Secs	0.1 Secs	20.0 Secs																				
A069	[Internal Freq]	0.0/240.0 Hz	0.1 Hz	60.0 Hz																				
A070	[Preset Freq 0] <sup>(1)</sup>	0.0/240.0 Hz	0.1 Hz	0.0 Hz																				
A071	[Preset Freq 1]			5.0 Hz																				
A072	[Preset Freq 2]			10.0 Hz																				
A073	[Preset Freq 3]			20.0 Hz																				
<sup>(1)</sup> To activate [Preset Freq 0] set P038 [Speed Reference] to option 4.																								
<table border="1" style="width: 100%; border-collapse: collapse;"> <thead> <tr> <th style="text-align: left;">Input State of Digital In 1 (/O Terminal 05)</th> <th style="text-align: left;">Input State of Digital In 2 (/O Terminal 06)</th> <th style="text-align: left;">Frequency Source</th> <th style="text-align: left;">Accel / Decel Parameter Used <sup>(2)</sup></th> </tr> </thead> <tbody> <tr> <td>0</td> <td>0</td> <td>[Preset Freq 0]</td> <td>[Accel Time 1] / [Decel Time 1]</td> </tr> <tr> <td>1</td> <td>0</td> <td>[Preset Freq 1]</td> <td>[Accel Time 1] / [Decel Time 1]</td> </tr> <tr> <td>0</td> <td>1</td> <td>[Preset Freq 2]</td> <td>[Accel Time 2] / [Decel Time 2]</td> </tr> <tr> <td>1</td> <td>1</td> <td>[Preset Freq 3]</td> <td>[Accel Time 2] / [Decel Time 2]</td> </tr> </tbody> </table>					Input State of Digital In 1 (/O Terminal 05)	Input State of Digital In 2 (/O Terminal 06)	Frequency Source	Accel / Decel Parameter Used <sup>(2)</sup>	0	0	[Preset Freq 0]	[Accel Time 1] / [Decel Time 1]	1	0	[Preset Freq 1]	[Accel Time 1] / [Decel Time 1]	0	1	[Preset Freq 2]	[Accel Time 2] / [Decel Time 2]	1	1	[Preset Freq 3]	[Accel Time 2] / [Decel Time 2]
Input State of Digital In 1 (/O Terminal 05)	Input State of Digital In 2 (/O Terminal 06)	Frequency Source	Accel / Decel Parameter Used <sup>(2)</sup>																					
0	0	[Preset Freq 0]	[Accel Time 1] / [Decel Time 1]																					
1	0	[Preset Freq 1]	[Accel Time 1] / [Decel Time 1]																					
0	1	[Preset Freq 2]	[Accel Time 2] / [Decel Time 2]																					
1	1	[Preset Freq 3]	[Accel Time 2] / [Decel Time 2]																					
<sup>(2)</sup> When a Digital Input is set to "Accel 2 & Decel 2", and the input is active, that input overrides the settings in this table.																								
A078	[Jog Frequency]	0.0/[Maximum Freq]	0.1 Hz	10.0 Hz																				
A079	[Jog Accel/Decel]	0.1/600.0 Secs	0.1 Secs	10.0 Secs																				
A080	[DC Brake Time]	0.0/90.0 Secs	0.1 Secs	0.0 Secs																				
A081	[DC Brake Level]	0.0/(Drive Amps × 1.8)	0.1 Amps	Amps × 0.05																				
A082	[DB Resistor Sel]	0/99	0 = Disabled 1 = Normal RA Res	2 = NoProtection 3-99 = % of Duty Cycle																				
A083	[S Curve %]	0/100%	1%	0% (Disabled)																				
A084	[Start Boost]	1/14	Settings in % of base voltage. <u>Variable Torque</u> <u>Constant Torque</u> 1 = "30.0, VT" 2 = "35.0, VT" 3 = "40.0, VT" 4 = "45.0, VT"	5 = "0.0, no IR" 6 = "0.0" 7 = "2.5, CT" 8 = "5.0, CT" 9 = "7.5, CT"																				
			10 = "10.0, CT" 11 = "12.5, CT" 12 = "15.0, CT" 13 = "17.5, CT" 14 = "20.0, CT"	8 7 (5 HP Drives)																				
A088	[Maximum Voltage]	20/Rated Volts	1 VAC	Rated Volts																				
A089	[Current Limit]	0.1/(Drive Amps × 1.8)	0.1 Amps	Amps × 1.5																				
A090	[Motor OL Select]	0/2	0 = "No Derate"	1 = "Min Derate" 2 = "Max Derate"																				
A091	[PWM Frequency]	2.0/16.0 kHz	0.1 kHz	4.0 kHz																				
A092	[Auto Rstrl Tries]	0/9	1	0																				
A093	[Auto Rstrl Delay]	0.0/300.0 Secs	0.1 Secs	1.0 Secs																				
A094	[Start At PowerUp]	0/1	0 = "Disabled"	1 = "Enabled"																				
A095	[Reverse Disable]	0/1	0 = "Rev Enabled"	1 = "Rev Disabled"																				
A096	[Flying Start En]	0/1	0 = "Disabled"	1 = "Enabled"																				
A097	[Compensation]	0/3	0 = "Disabled" 1 = "Electrical"	2 = "Mechanical" 3 = "Both"																				
A098	[SW Current Trip]	0.0/(Drive Amps × 2)	0.1 Amps	0.0 (Disabled)																				
A099	[Process Factor]	0.1/999.9	0.1	30.0																				
A100	[Fault Clear]	0/2	0 = "Ready/Idle"	1 = "Reset Fault" 2 = "Clear Buffer"																				
A101	[Program Lock]	0/1	0 = "Unlocked"	1 = "Locked"																				
A102	[Testpoint Sel]	0/FFFF	1 Hex	400																				

No.	Parameter	Min/Max	Display/Options	Default
A103	[Comm Data Rate] <sup>(9)</sup>	0/5	0 = "1200" 1 = "2400" 2 = "4800" 3 = "9600" 4 = "19.2K" 5 = "38.4K"	3
A104	[Comm Node Addr] <sup>(9)</sup>	1/247	1	100
A105	[Comm Loss Action]	0/3	0 = "Fault" 1 = "Coast to Stop" 2 = "Stop" 3 = "Continu Last"	0
A106	[Comm Loss Time]	0.1/60.0	0.1	5.0
A107	[Comm Format] <sup>(9)</sup>	0/5	0 = "RTU 8-N-1" 1 = "RTU 8-E-1" 2 = "RTU 8-O-1" 3 = "RTU 8-N-2" 4 = "RTU 8-E-2" 5 = "RTU 8-O-2"	0
A110	[Anlg In 0-10V Lo]	0.0/100.0%	0.1%	0.0%
A111	[Anlg In 0-10V Hi]	0.0/100.0%	0.1%	100.0%
A112	[Anlg In4-20mA Lo]	0.0/100.0%	0.1%	0.0%
A113	[Anlg In4-20mA Hi]	0.0/100.0%	0.1%	100.0%
A114	[Slip Hertz @ FLA]	0.0/10.0 Hz	0.1 Hz	2.0 Hz
A115	[Process Time Lo]	0.00/99.99	0.01	0.00
A116	[Process Time Hi]	0.00/99.99	0.01	0.00

<sup>(9)</sup> Power to drive must be cycled before any changes will affect drive operation.

## Fault Codes

To clear a fault, press the Stop key, cycle power or set A100 [Fault Clear] to 1 or 2.

No.	Fault	Description
F2	Auxiliary Input <sup>(1)</sup>	Check remote wiring.
F3	Power Loss	Monitor the incoming AC line for low voltage or line power interruption.
F4	UnderVoltage <sup>(1)</sup>	Monitor the incoming AC line for low voltage or line power interruption.
F5	OverVoltage <sup>(1)</sup>	Monitor the AC line for high line voltage or transient conditions. Bus overvoltage can also be caused by motor regeneration. Extend the decel time or install dynamic brake option.
F6	Motor Stalled <sup>(1)</sup>	Increase [Accel Time x] or reduce load so drive output current does not exceed the current set by parameter A089 [Current Limit].
F7	Motor Overload <sup>(1)</sup>	An excessive motor load exists. Reduce load so drive output current does not exceed the current set by parameter P033 [Motor OL Current].
F8	Heatsink OvrTmp <sup>(1)</sup>	Check for blocked or dirty heat sink fins. Verify that ambient temperature has not exceeded 40°C (104°F) for IP 30/NEMA 1/UL Type 1 installations or 50°C (122°F) for Open type installations. Check fan.
F12	HW OverCurrent <sup>(1)</sup>	Check programming. Check for excess load, improper DC boost setting, DC brake volts set too high or other causes of excess current.
F13	Ground Fault	Check the motor and external wiring to the drive output terminals for a grounded condition.
F33	Auto Rstrt Tries	Correct the cause of the fault and manually clear.
F38	Phase U to Gnd	Check the wiring between the drive and motor. Check motor for grounded phase.
F39	Phase V to Gnd	Replace drive if fault cannot be cleared.
F40	Phase W to Gnd	
F41	Phase UV Short	Check the motor and drive output terminal wiring for a shorted condition.
F42	Phase UW Short	Replace drive if fault cannot be cleared.
F43	Phase VW Short	
F48	Params Defaulted	The drive was commanded to write default values to EEPROM. Clear the fault or cycle power to the drive. Program the drive parameters as needed.
F63	SW OverCurrent <sup>(1)</sup>	Check load requirements and A098 [SW Current Trip] setting.
F64	Drive Overload	Reduce load or extend Accel Time.
F70	Power Unit	Cycle power. Replace drive if fault cannot be cleared.
F71	Net Loss	The communication network has faulted.
F81	Comm Loss	If adapter was not intentionally disconnected, check wiring to the port. Replace wiring, port expander, adapters or complete drive as required. Check connection. An adapter was intentionally disconnected. Turn off using A105 [Comm Loss Action].
F100	Parameter Checksum	Restore factory defaults.
F122	I/O Board Fail	Cycle power. Replace drive if fault cannot be cleared.

<sup>(1)</sup> Auto-Reset/Run type fault. Configure with parameters A092 and A093.

## Drive Dimensions

PowerFlex 4 Panel Mount Drives – Ratings are in kW and (HP)

Frame	120V AC – 1-Phase	240V AC – 1-Phase No Brake	240V AC – 1-Phase	240V AC – 3-Phase	480V AC – 3-Phase
A	0.2 (0.25) 0.37(0.5)	0.2 (0.25) 0.37 (0.5) 0.75 (1.0)	0.2 (0.25) 0.37 (0.5) 0.75 (1.0)	0.2 (0.25) 0.37 (0.5) 0.75 (1.0) 1.5 (2.0)	0.37 (0.5) 0.75 (1.0) 1.5 (2.0)
B	0.75(1.0) 1.1 (1.5)	1.5 (2.0) 2.2 (3.0)	1.5 (2.0)	2.2 (3.0) 3.7 (5.0)	2.2 (3.0) 3.7 (5.0)

**PowerFlex 4 Panel Mount Drives** <sup>(1)</sup>– Dimensions are in millimeters and (inches).  
Weights are in kilograms and (pounds).

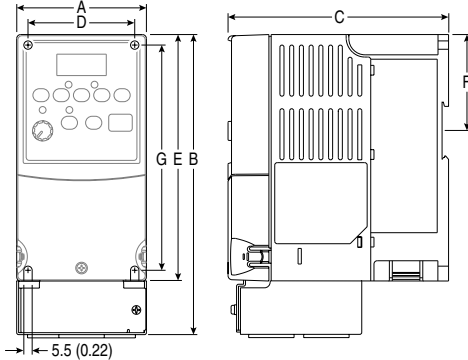

Frame	A	B <sup>(2)</sup>	C	D	E <sup>(3)</sup>	F	G	Shipping Weight
A	80 (3.15)	185 (7.28)	136 (5.35)	67 (2.64)	152 (5.98)	59.3 (2.33)	140 (5.51)	1.4 (3.1)
B	100 (3.94)	213 (8.39)	136 (5.35)	87 (3.43)	180 (7.09)	87.4 (3.44)	168 (6.61)	2.2 (4.9)

(1) Flange Mount drives are also available. Refer to the PowerFlex 4 *User Manual* on CD for information.

(2) Overall height of drive with IP 30/NEMA 1/UL Type 1 option kit installed.

(3) Overall height of standard IP 20/Open Type drive.

**IP 30/NEMA 1/UL Type 1 Option Kit** – Dimensions are in millimeters and (inches)

